

THIS DRAWING HAS BEEN GENERATED BY A CAD SYSTEM. CHANGES SHALL ONLY BE INCORPORATED AS DIRECTED BY THE DESIGN ACTIVITY. DO NOT REVISE MANUALLY.

REVISIONS			
REV.	DESCRIPTION	ECO	DATE
A	INITIAL RELEASE	I.R.	12/20/15
			APPROVED
			P.T

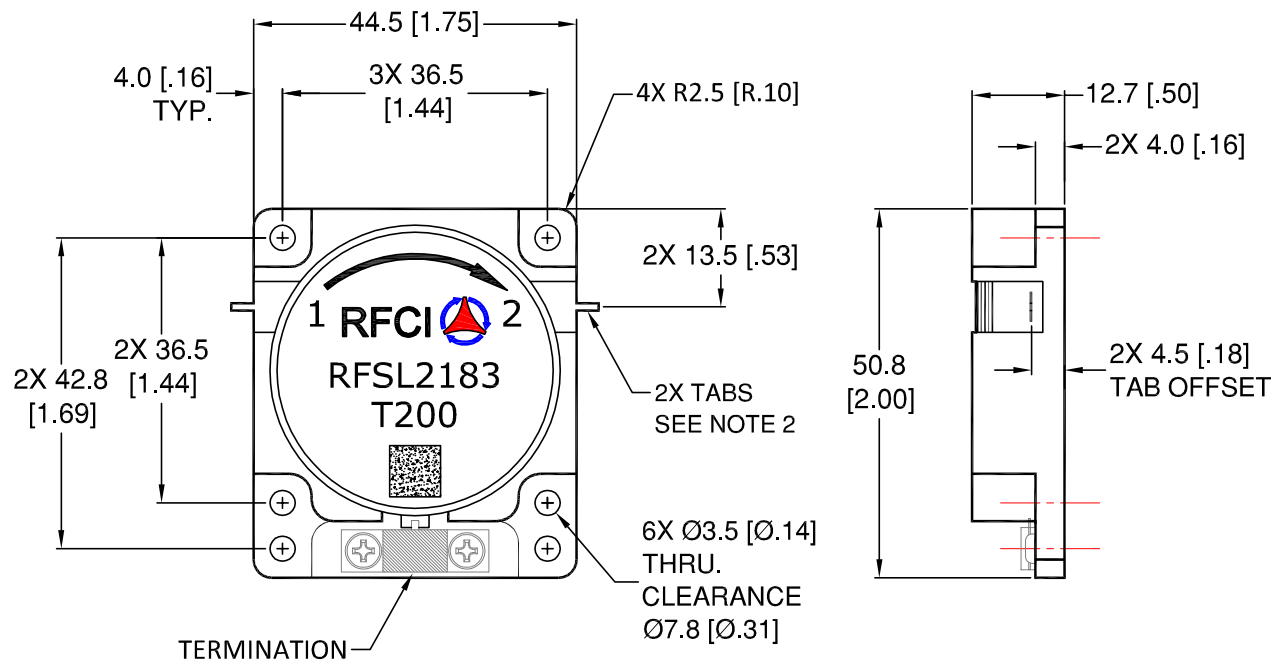

Specifications

Parameter	Minimum	Typical	Maximum
Frequency Range (MHz)	325		400
Insertion Loss (dB)		< .40	.50
Isolation (dB)	18	> 21	
Return Loss (dB)	18	> 21	

Power & Temperature Ratings

Parameter	Maximum
Forward PWR Peak/AVG	1000/200 Watts
Reverse Power CW	200 Watts
Termination Rating (See Note 3)	200 Watts
Operating Temperature	-20 to +85° C
Storage Temperature	-40 to +95° C

- Notes:
1. Typical Values Represent Performance @ +23 °C.
 2. Tab Dimensions: 1.00 [.040]W x 3.0 [.12]L x 0.20 [.008]T
 3. Isolator Flange held to +85°C; 30 Minute Maximum Duration.

CW 200W ISOLATOR MODEL: RFSL2183-T200

UNLESS OTHERWISE SPECIFIED ALL DIMENSIONS ARE IN MILLIMETERS [INCHES]: TOLERANCES ARE: 1 PLACE DECIMAL ±.2 [±.01] ANGULAR: ±1.0° 2 PLACE DECIMAL ±.10 [±.004] SURFACE ROUGHNESS 16/	THIRD ANGLE PROJECTION 						
	APPROVALS DRAWN BY: CHECKED BY: DESIGN BY: ENGINEER BY: MFG. ENGR. Q.A. PROG. MGMT/MKT	DATE			OUTLINE/SPECS		
REMOVE ALL BURRS AND BREAK SHARP EDGES. SURFACE TEXTURE TO BE IN ACCORDANCE WITH LATEST ANSI B46.1 DIMENSIONING & TOLERANCING IN ACCORDANCE WITH LATEST ANSI Y14.5	PROPRIETARY NOTE: "THE INFORMATION CONTAINED ON THIS DOCUMENT IS CONSIDERED TO BE CONFIDENTIAL MATERIAL PROPRIETARY TO RF CIRCULATOR ISOLATOR Inc. (RFCI) AND IS PROVIDED SOLELY FOR INFORMATION PURPOSES. THIS INFORMATION SHALL NOT BE USED BY ANYONE OTHER THAN RFCI TO DESIGN OR CONSTRUCT ANY OF THE ITEMS DEPICTED, NOR SHALL IT BE DISCLOSED, DUPLICATED, OR COPIED FOR ANY PURPOSE, NOR MADE AVAILABLE TO ANY THIRD PARTY WITHOUT THE PRIOR WRITTEN CONSENT OF A RFCI OFFICIAL."			SIZE A	CAGE NO.	DWG NO. SL2183-T200-OS	REV. A
DO NOT SCALE DRAWING	SCALE: FULL		SHEET 1 OF 1				