

THIS DRAWING HAS BEEN GENERATED BY A CAD SYSTEM. CHANGES SHALL ONLY BE INCORPORATED AS DIRECTED BY THE DESIGN ACTIVITY. DO NOT REVISE MANUALLY.

REVISIONS			
REV.	DESCRIPTION	ECO	DATE
A	INITIAL RELEASE	I.R.	08/02/15
			APPROVED
			P.T

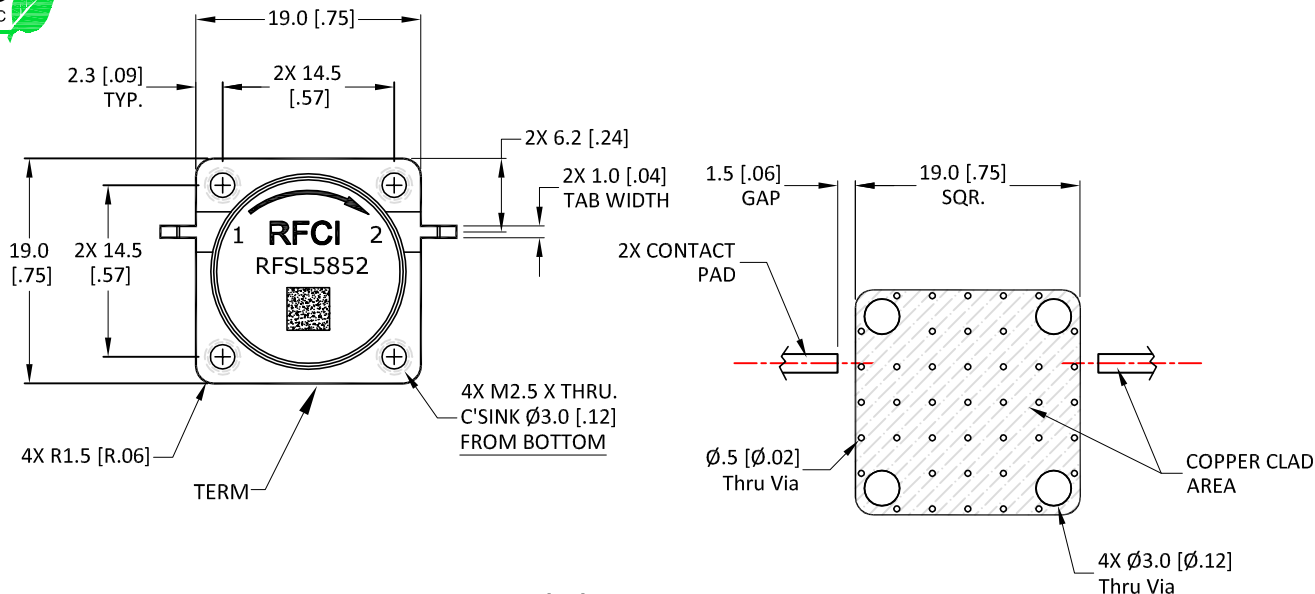

Recommended Footprint

The Land Pattern should be with good thermal conductivity

Finish:
 Housing: Nickel plated
 Tabs: Silver plated
 Coplanarity specification: 0.10 [0.004] MAX.

Specifications

Parameter	Minimum	Typical	Maximum
Frequency Range (MHz)	2620		2690
Insertion Loss (dB)		< .25	.30
Isolation (dB)	20	> 23	
Return Loss (dB)	20	> 23	

Power & Temperature Ratings

Parameter	Maximum
Forward PWR Peak/AVG	500/80 Watts
Reverse Power CW	20 Watts
Termination Rating (See Note 2)	20 Watts
Operating Temperature	-40 to +85° C
Storage Temperature	-40 to +85° C

Notes:

1. Typical Values Represent Performance @ +23 °C.
2. Isolator Flange held to +85°C; 30 Min. maximum Duration.

CW GW SMD ISOLATOR MODEL: RFSL5852

<p>UNLESS OTHERWISE SPECIFIED ALL DIMENSIONS ARE IN MILLIMETERS [INCHES]:</p> <p>TOLERANCES ARE: 1 PLACE DECIMAL ±.2 [±.01] ANGULAR: ±1.0° 2 PLACE DECIMAL ±.10 [±.004] SURFACE ROUGHNESS 16/</p> <p>REMOVE ALL BURRS AND BREAK SHARP EDGES. SURFACE TEXTURE TO BE IN ACCORDANCE WITH LATEST ANSI B46.1 DIMENSIONING & TOLERANCING IN ACCORDANCE WITH LATEST ANSI Y14.5</p> <p>PROPRIETARY NOTE: "THE INFORMATION CONTAINED ON THIS DOCUMENT IS CONSIDERED TO BE CONFIDENTIAL MATERIAL PROPRIETARY TO RF CIRCULATOR ISOLATOR Inc. (RFCI) AND IS PROVIDED SOLELY FOR INFORMATION PURPOSES. THIS INFORMATION SHALL NOT BE USED BY ANYONE OTHER THAN RFCI TO DESIGN OR CONSTRUCT ANY OF THE ITEMS DEPICTED, NOR SHALL IT BE DISCLOSED, DUPLICATED, OR COPIED FOR ANY PURPOSE, NOR MADE AVAILABLE TO ANY THIRD PARTY WITHOUT THE PRIOR WRITTEN CONSENT OF A RFCI OFFICIAL."</p>	<p>THIRD ANGLE PROJECTION</p>	<p>RFCI</p>
	<p>APPROVALS</p> <p>DATE</p>	
<p>DO NOT SCALE DRAWING</p>	<p>DRAWN BY:</p> <p>CHECKED BY:</p> <p>DESIGN BY:</p> <p>ENGINEER BY:</p> <p>MFG. ENGR.</p> <p>Q.A.</p> <p>PROG. MGMT/MKT</p>	<p>SIZE</p> <p>A</p>
		<p>CAGE NO.</p> <p>DWG NO.</p> <p>SL5852-OS</p>
		<p>REV.</p> <p>A</p>
	<p>SCALE: FULL</p>	<p>SHEET 1 OF 1</p>